

LP SmartSide Perfection Shingle

Application Instructions Fiber Substrate Lap Siding

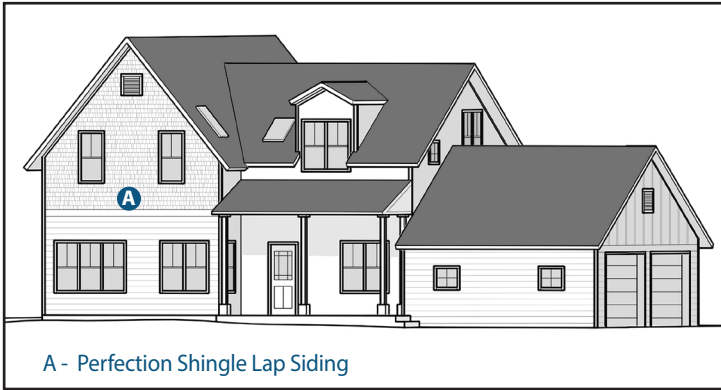

A - Perfection Shingle Lap Siding



ON SITE STORAGE

- Store off the ground well supported, on a flat well-drained surface. (Diagram 1a)
- Additional support may be required to achieve a safe clearance from the ground.
- Store products under a roof or separate waterproof covering. (Diagram 1a)
- When the waterproof covering is removed, cut all unit banding.
- Keep siding clean and dry. Inspect prior to installation.

1a

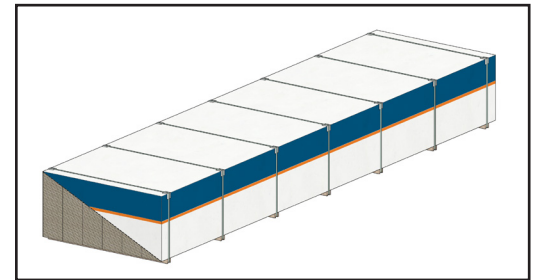

PREPARATION

General Information

- At the time of manufacture, siding meets or exceeds the performance standards set forth in Composite Panel Association ANSI 135.6 and has achieved code recognition under ESR-3090 and CCMC 12353-L. For copies of these reports, call LP Customer Support at 800-648-6893 or go online at <https://lpcorp.com/resources/product-literature/#>.
- LP's application instructions describe the minimum requirements needed to assure LP® SmartSide® Limited Warranty coverage.
- Failure to follow the LP application instructions could result in reduced product service life and may lead to denial of coverage under the LP SmartSide Limited Warranty.

Before You Begin

- Minimum 6 inch clearance must be maintained between siding and finish grade.
- Siding applied adjacent to porches, patios, walks, etc. must have a clearance of at least 1 inch above any surface.
- Siding must not be in direct contact with masonry, concrete, brick, stone, stucco or mortar. Backer rod is recommended to properly space materials at these location.
- Minimum 1 inch clearance from roof surfaces. (Diagram 2a)
- Apply siding in a manner that prevents moisture intrusion and water buildup.
- All exposed wood substrate must be sealed in a manner that prevents moisture intrusion and water build up. To achieve this, use primer, paint, sealant and flashings as follows in these application instructions.
- Do not use staples.
- **Siding is designed to be installed directly to wood structural panel wall sheathing.**

LP SmartSide Perfection Shingle

PREPARATION

Trim

- Trim should be thick enough so the siding does not extend beyond the face of the trim.
- Trim and fascia must be applied in a manner that will not allow moisture intrusion or water buildup.

Moisture Control

- Moisture control and moisture vapor control are critical elements of proper housing design and construction. Check your local building codes for application procedures for handling moisture and water vapor in your area.
- Follow all applicable building code specifications relating to prevention of moisture intrusion into the wall assembly. LP® SmartSide® siding is a wood product, and, as with all wood products, must be kept free from excessive moisture. Lack of proper ventilation; exposure to constant or repetitive sources of water such as sprinklers, condensation, inadequate flashing; improper sealing; or failure to follow common building practices that prevent moisture intrusion into the wall system may cause damage, and products subject to such treatment will be excluded from warranty coverage.
- As with all wood products, do not apply engineered wood siding to a structure having excessive moisture conditions such as drying concrete, plaster, or wet blown cellulose insulation. If such conditions exist, the building should be well ventilated to allow it to dry prior to the application of the siding.
- Gutters with kick-out flashing and eave drip edge are recommended for control of roof water run off.

Flashing, Windows, Doors & Openings

- All openings must be properly sealed or flashed in a manner that prevents moisture intrusion or buildup. Several examples that accomplish this are shown on the following pages.

Secondary Water-Resistant Barrier

- A properly installed breathable water-resistive barrier is required behind the siding. Consult your local building code for details.
- LP will assume no responsibility for water penetration, or damage it may cause.

Water Run-Off Control

- Properly installed flashing materials will help direct water away from common water collecting areas.
- All flashing material shall be metal or another durable material that under normal outdoor environmental conditions will last for a period of not less than 50 years.
- All flashing materials must have a minimum 4 inch upper leg. Add a 4 inch wide adhesive flashing to flashing legs less than 4 inches.
- Properly integrate flashing with the secondary WRB. Use housewrap, flashing tape, kickout flashing, step flashing, Z-flashing, drip edge, gutters or other items as needed to maintain the counter-flashing principle.
- Install kickout flashing to direct the water into the gutter. (Diagram 2a)
- Install step flashing that has a minimum 4 inch upper leg. (Diagram 2a)
- Maintain a minimum 1 inch clearance between the end of the gutter and the adjoining wall to allow for proper maintenance of the siding. (Diagram 2b)
- Do not extend the siding or trim into the kickout flashing or gutter.
- Prime and paint ALL exposed cut edges of siding.

2a

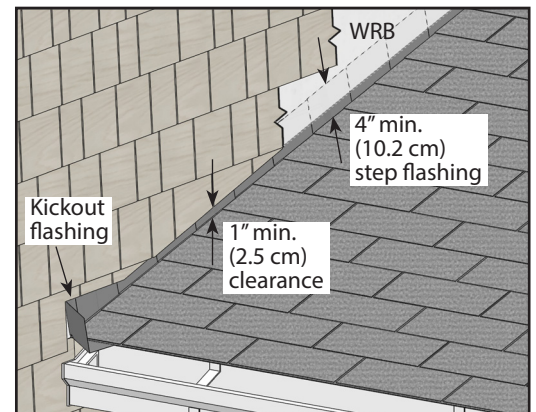

2b

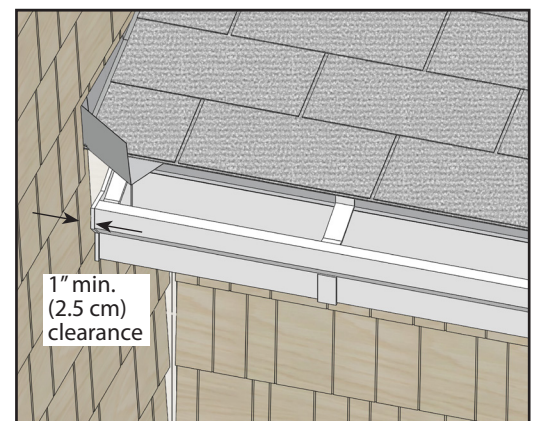

LP SmartSide Perfection Shingle

PREPARATION

Cutting

- For the cleanest cut and longer blade life, a fine-tooth carbide tipped blade is recommended.
- Siding is manufactured with a special edge coating which reduces moisture-related issues. If siding is ripped you must take special care to prime, paint and seal all exposed wood fiber as described in the finishing section.
- Climb cut the surface of the siding such that the rotation of the blade cuts downward on the primed or prefinished surface.
- **Do not miter edges.**

General Application Equipment

Ring Shank Diameter $\geq 0.092''$		Hot-Dipped Galvanized	
CONDITION		CORRECTION	
Snug		OK	
Flush		OK	
Visible Fiber		Paint	
Countersunk 1/16"-1/8" (2 mm-3 mm)		Apply Sealant	
Countersunk more than 1/8" (3 mm)		Apply Sealant & re-nail	

Table 3a

- **Fasteners:** Minimum **0.092 inch** diameter, hot-dipped galvanized **ring shank** nail (ASTM A153) or equivalent. Apply and correct overdriven nails as shown in Table 3a.
- **Sealant:** Use an exterior-quality, non-hardening, paintable sealant. Use a Class 25 or higher exterior sealant meeting the ASTM C920 Standard for Specification for Elastomeric Joint Sealants. Follow the sealant manufacturer's instructions for application.
- **Paint:** An exterior-quality 100% acrylic latex paint, specially formulated for use on wood and engineered wood substrates, is highly recommended. Semi-gloss or satin finish oil or alkyd paints are acceptable. For flat alkyd paint, please check with the coating manufacturer for their recommendations for use on composite wood siding.

INSTALLATION

Fastening Instructions - Sheathing Only

- Install over wood structural panels a minimum 7/16 Category with an APA® Trademark that contains the consensus Standard DOC PS 1 or PS 2. Exception: LP® FlameBlock® Fire-Rated OSB Sheathing.
- **Fastener length:** Long enough to fully penetrate wood structural panel sheathing by at least 1/4 inch. Ensure that the ring shanks of the fastener fully engage the wood structural panel sheathing. (Diagram 3a)
- **Fastener placement:** A minimum 3/4 inch down from top edge of siding. Fasteners shall be placed 1 inch from ends, excluding the width of the shiplap. (Diagram 3a)
- **Fastener spacing:** Space ring shank nails a maximum of 8 inches o.c. across the top of siding. (Diagram 4a)
- Use a minimum **0.092 inch** diameter shank, hot-dipped galvanized or stainless steel **ring shank** nail. Fasteners shall be corrosion resistant and capable of preventing rust, stain and deterioration under normal outdoor environmental conditions for a period of no less than 50 years.

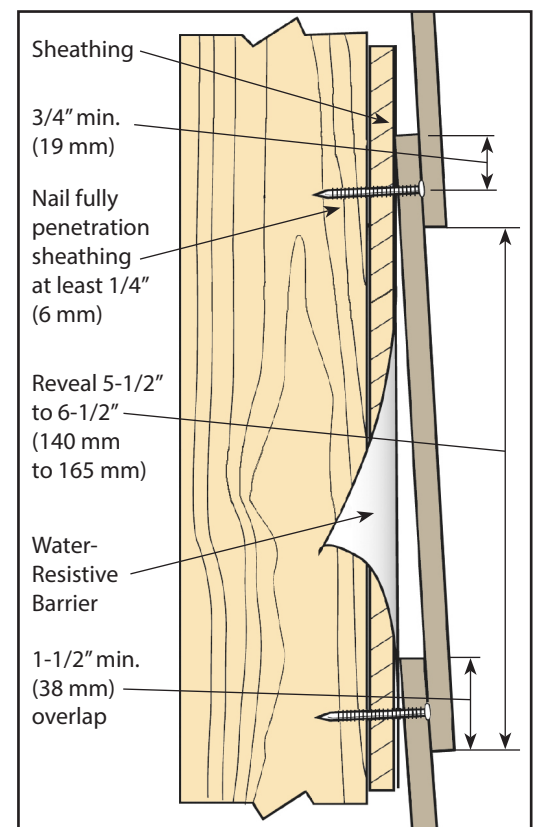

3a

LP SmartSide Perfection Shingle

INSTALLATION

Fastening Instructions - Sheathing Only *(continued)*

- Apply siding to wall assembly directly to wood structural panel sheathing.
- Begin by nailing a starter strip (approximately 3/8 inch thick x 1-1/2 inch wide) flush with bottom edge of sill plate.
- Starting from left to right, level and install the siding so the bottom edge is no more than 1/2 inch below the starter strip.
- Use the alignment bead in shi lap edge as a spacing guide. Do not overlap the alignment bead. (Diagrams 4b & 5b)
- To obtain the best staggered joint appearance of siding, cut and fasten the starter pieces of each course according to the following steps:
 - Cut 1st course starter piece 3/4 inch from the left, this will remove only the top shi lap from the overall length of panel,
 - Cut 2nd course starter piece 13 inches from the left, that measurement includes the length of the shi lap,
 - Cut 3rd course starter piece 6 inches from the left, that measurement includes the length of the shi lap,
 - Cut 4th course starter piece 8 inches from the left, that measurement includes the length of shi lap,
 - **Repeat** this same sequence every four courses. (Diagram 4a)
- Lap a minimum of 1-1/2 inches. This will vary based on siding reveal selected. Reveal can be between 5-1/2 to 6-1/2 inches.
- The siding should fit against corner trim boards leaving a 3/16 inch space, the opposite shi lap edge is facing up to receive the next piece of siding.

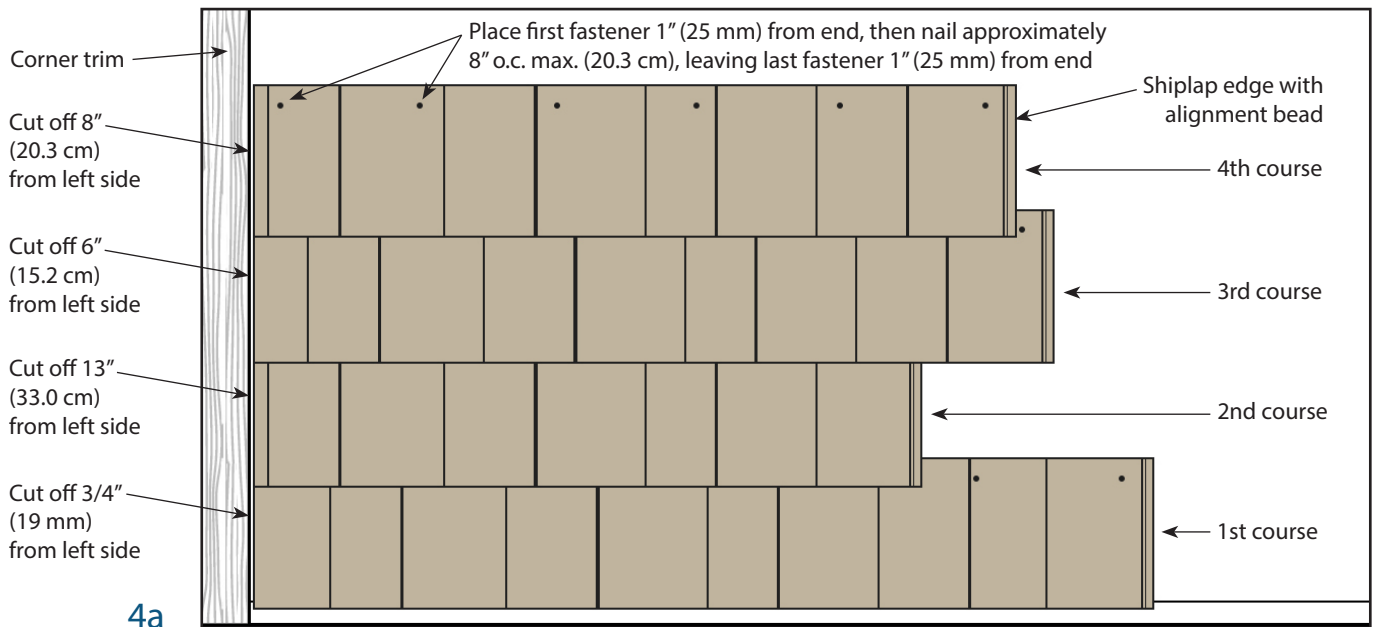

4a

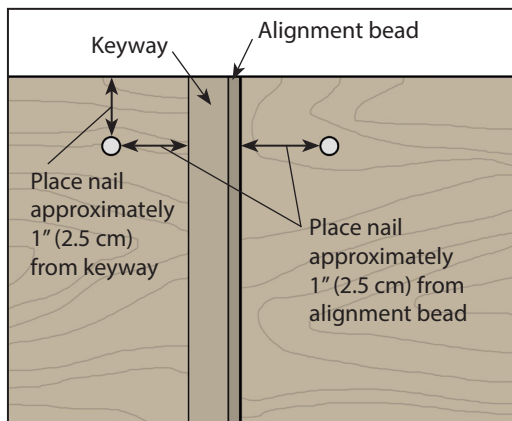

4b

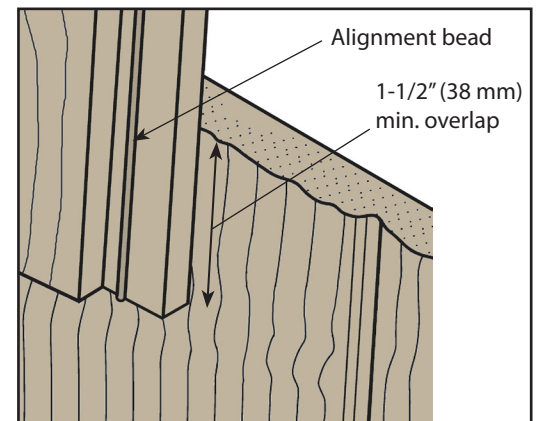

4c

LP SmartSide Perfection Shingle

INSTALLATION

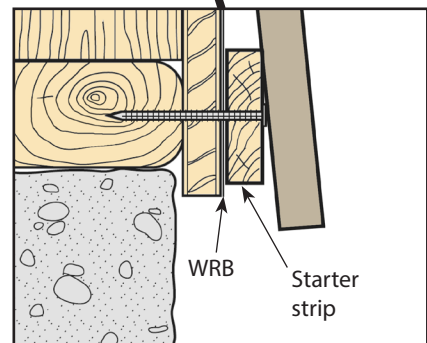
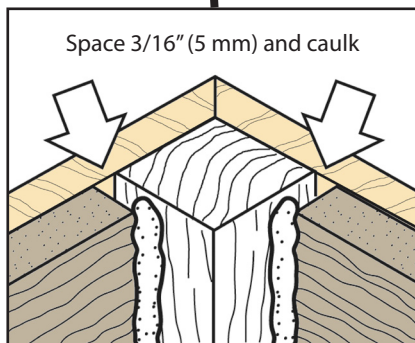
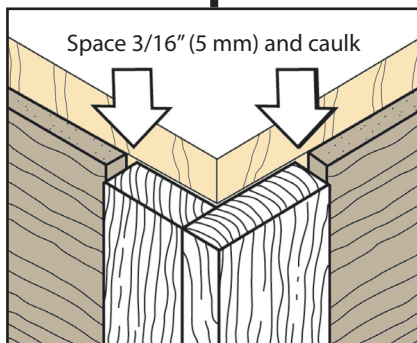
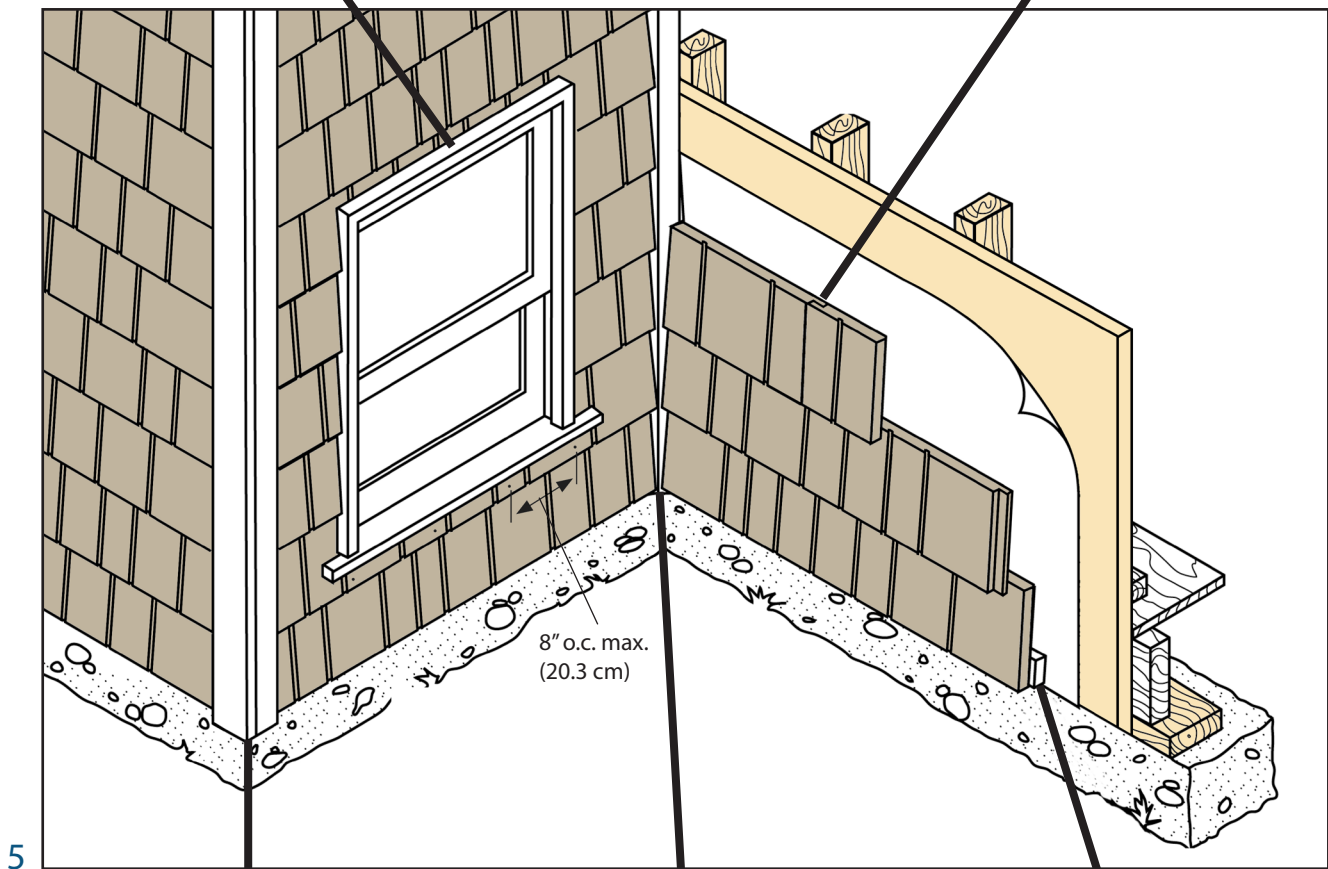
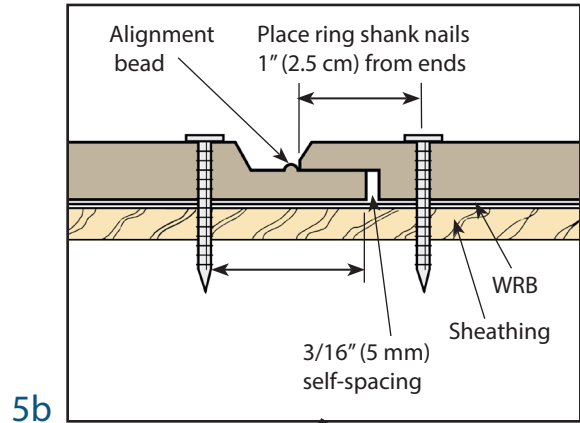
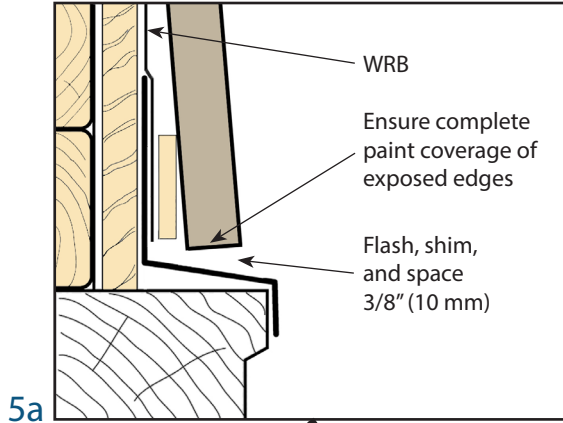

LP SmartSide Perfection Shingle

INSTALLATION

Alternative Fastening Option:

Rigid Foam Insulation over Furring Strips, or on Concrete/Masonry Walls over Furring Strips

- Install over a minimum 1x4 nominal size Southern Pine furring strips with a specific gravity greater than or equal to 0.55, no more than 16 inches o.c. in wind speed areas less than or equal to 200 mph.
- Fastened with a minimum **0.120 inch** shank diameter, hot dip galvanized (ASTM A153) or stainless steel **ring shank** nail.
- Nail a minimum 3/4 inch down from top edge of the siding.
- Lap a minimum of 1-1/2 inches. This will vary based on siding reveal selected. Reveal can be 5-1/2 to 6-1/2 inches.
- Blind nail with a minimum of two ring shank nails per furring strip. (Diagram 6a)
- Shiplap joints shall occur over furring strips. (Diagram 6a)
- Fastener length shall fully penetrate a minimum 1/2 inch into furring strips. Caution: fastener shall not bottom out on a masonry wall leaving the fastener head less than flush with the face of trim or siding.
- Siding shall be installed to safely resist all loads, including wind loads, of the locally adopted building codes. The installation of siding shall result in a system that provides a load path that meets the requirements for the transfer of loads from their point of origin through the load-resisting elements to the structure. The mechanical connection of the furring strip to structure is the responsibility of a design professional. LP assumes no liability for any loss or damage caused by the design of the mechanical connection of the furring strip to the structure and is expressly released by the purchaser or owner from any such loss or liability.
- The 2015 IRC and 2014 Florida Residential Code require a water-resistant barrier be used on all exterior walls, except over concrete or masonry walls per Exception 1 in Section R703.1.1 of both Codes. LP always requires the use of a WRB behind LP® SmartSide® products. LP will assume no responsibility for any damage or condition arising from a failure to use a WRB.
- Louisiana-Pacific will assume no responsibility for any damage or condition arising from the use of rigid foam insulation.

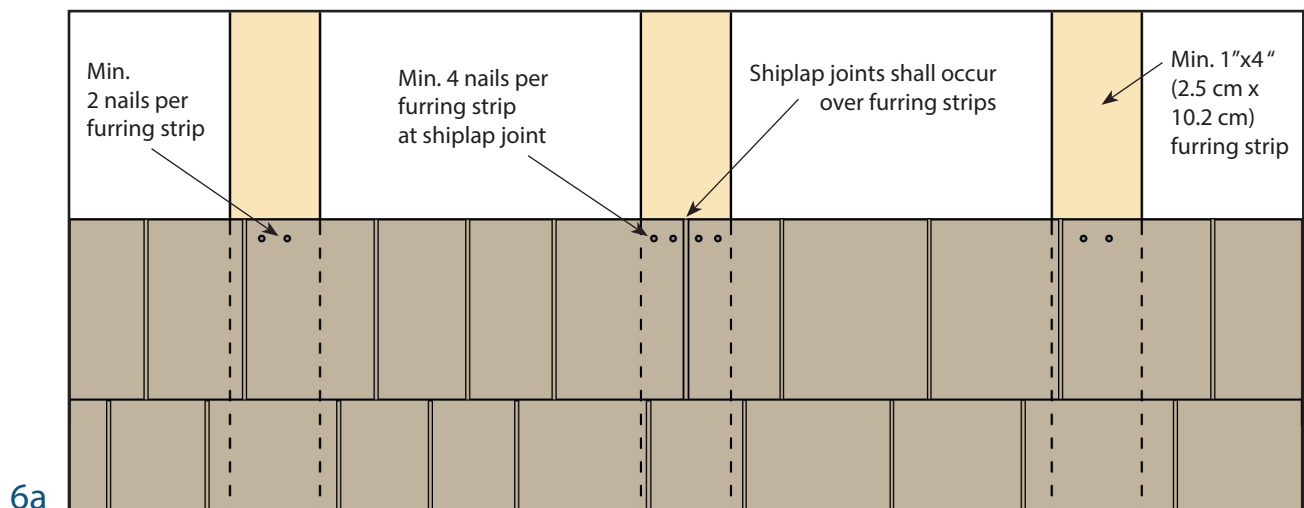

6a

- Minimum 2 fasteners per furring strip
- Minimum 4 fasteners per furring strip at shiplap joint

LP SmartSide Perfection Shingle

INSTALLATION

Finishing Instructions

- Prime all exposed wood substrate before painting.
- Thoroughly paint the bottom edges of siding, especially all cut ends next to the roof line.
- Apply paint as soon as possible and within 180 days of application.
- Follow the coating manufacturer's application and maintenance instructions.

DO NOT USE:

- Semi-transparent and transparent stain.
- Shake and shingle paints.
- Vinyl-based resin formulas such as vinyl acetate, PVA, vinyl acetate/acrylic copolymer paints.

CAUTION:

HANDLE PREFINISHED LP SMARTSIDE PRODUCTS WITH EXTREME CARE DURING STORAGE AND APPLICATION. TOUCH UP ANY DAMAGE TO THE FINISH THAT MAY OCCUR DURING APPLICATION PER PREFINISHERS SPECIFICATIONS.

LIMITED WARRANTY

The Louisiana-Pacific Corporation ("LP") LP® SmartSide® Trim and Siding (the "Products") Limited Warranty (the "Warranty") applies only to structures on which the Products have been applied, finished and maintained in accordance with the published application, finishing and maintenance instructions in effect at the time of application. Products affected by a failure to follow such application, finishing or maintenance instructions ("Affected Products") will be excluded from coverage under the Warranty.

LP assumes no liability for any loss or damage caused by the Affected Products and is expressly released by the purchaser or owner from any such loss or liability.

Any modification of the Warranty or the application, finishing and maintenance requirements is void unless approved in writing by LP prior to application.

For a copy of the warranty or installation and technical support, visit the LP Web site at:
WARRANTY REMEDIES ARE NOT AVAILABLE IF REQUIREMENTS ARE NOT FOLLOWED.

www.lpcorp.com
or for additional support call 800-450-6106

Cal. Prop 65 Warning: Use of this product may result in exposure to wood dust, known to the State of California to cause cancer.



Louisiana-Pacific Corporation
414 Union Street, Suite 2000
Nashville, TN 37219

www.lpcorp.com
www.lpsmartside.com

© 2017 Louisiana-Pacific Corporation. All rights reserved. LP, SmartSide, and FlameBlock are registered trademarks of Louisiana-Pacific Corporation. APA is a registered trademark of APA - The Engineered Wood Association.

NOTICE: Louisiana-Pacific Corporation periodically updates and revises its product information. The information in this document is subject to change without notice. To verify that this version is current, call 800-450-6106.